

GB Cleaning and maintenance of this product

Congratulations on buying this high-quality product. To ensure your long-term satisfaction, please adhere to following cleaning advice.

- Lift up or remove the cover and seat when cleaning, as fumes rising from cleaning and disinfecting agents can damage the plastic.
- The pore-free surface of this product already offers the best protection for optimal hygiene. Therefore it is sufficient to use mild natural household cleaner. Avoid scouring, aggressive chlorine based and acid based cleaning agents.
- Dry hinges well after cleaning.

F Nettoyage et entretien de ce produit

Félicitations, vous venez d'acheter un produit de haute qualité. Afin de pouvoir en profiter le plus longtemps possible, nous vous conseillons de suivre les règles d'entretien suivantes :

- Lors du nettoyage de la cuvette, le couvercle et la lunette doivent être toujours relevés ou enlevés. Vous éviterez ainsi que les émanations des produits de nettoyage ou de désinfection n'altèrent le plastique.
- La surface de ce produit est conçue pour fournir une hygiène optimale. C'est pourquoi des produits d'entretien doux et non agressifs suffisent. L'usage de détergents à base de chlore et d'acide sont à éviter.
- Après le nettoyage, essuyez bien les charnières.

D Reinigung und Pflege diese Produktes

Herzlichen Glückwunsch, Sie haben ein qualitativ hochwertiges Produkt erworben. Damit Sie lange Freude daran haben, bitte wir Sie, die folgenden Pflegehinweise zu beachten :

- Bei der Reinigung des Beckens sollte der Deckel und Sitzring stets hochgeklappt oder abgenommen sein, da eventuell aufsteigenden Dämpfe von Reinigungs- oder Desinfektionsmitteln den Kunststoff angreifen können.
- Die porenfreie Oberfläche dieses Produktes bietet bereits die beste Voraussetzung für optimale Hygiene. Deshalb genügen milde und am besten natürliche Haushaltsreiniger Scheuermilch, aggressive chlor- und säurehaltige Reinigungsmittel sind zu vermeiden.
- Scharniere nach der Reinigung gut abtrocknen.

NL Reiniging en onderhoud van dit product

Hartelijk gefeliciteerd, u heeft een kwalitatief hoogwaardig product gekocht. Om ervoor te zorgen dat u er lang plezier van zult hebben, verzoeken wij u de volgende onderhoudsinstructies in acht te nemen:

- Bij de reiniging van de pot moeten het deksel en de bril altijd omhoog worden geklapt of worden verwijderd, omdat eventueel opstijgende dampen van reinigings- of desinfectiemiddelen de kunststof kunnen aantasten.
- Het poriënvrije oppervlak van dit product biedt al de beste voorwaarde voor optimale hygiëne. Daarom zijn milde en het liefst natuurlijke huishoudreinigingsmiddelen voldoende. Schurende, agressieve reinigingsmiddelen die chloor en zuren bevatten, mogen niet worden gebruikt.
- Maak de scharnieren na het reinigen goed droog.

I Pulizia e manutenzione

Congratulazioni, avete acquistato un prodotto di alta qualità. Per garantirne la funzionalità a lungo termine, vi invitiamo a seguire i nostri consigli :

- Sollevare o rimuovere il sedile e la ciambella durante la pulizia del WC poiché i vapori generati dagli agenti pulenti e disinfettanti possono danneggiare la plastica.
- La superficie priva di pori di questo prodotto offre la migliore protezione per un'igiene ottimale, pertanto è sufficiente usare dei normali detersivi per le pulizie domestiche, evitando prodotti aggressivi, a base di cloro o acidi.
- Asciugare bene le cerniere dopo la pulizia.

(GB) Instruction for Soft Close seat closing time adjustment

(D) Anleitung zur Einstellung der Schließzeit für WC-Sitze mit Absenkautomatik

(F) Instructions de réglage des abattants à fermeture ralentie

(NL) Instructies ter behoeven van sluittijd aanpassing voor Soft Close zitting

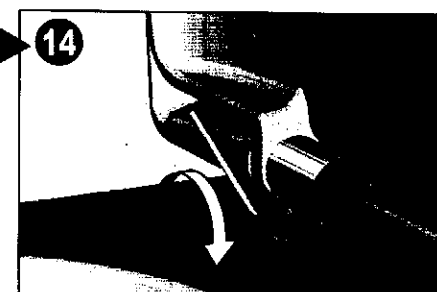
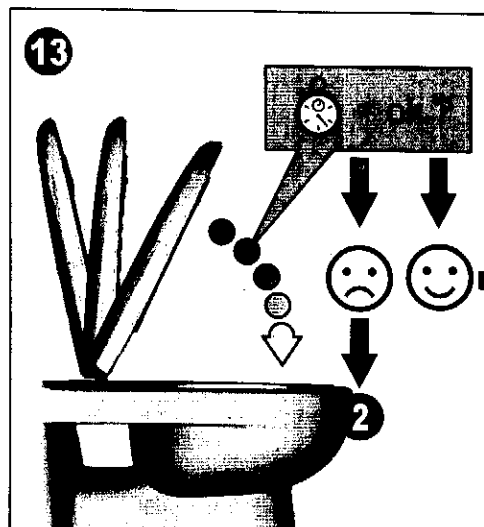
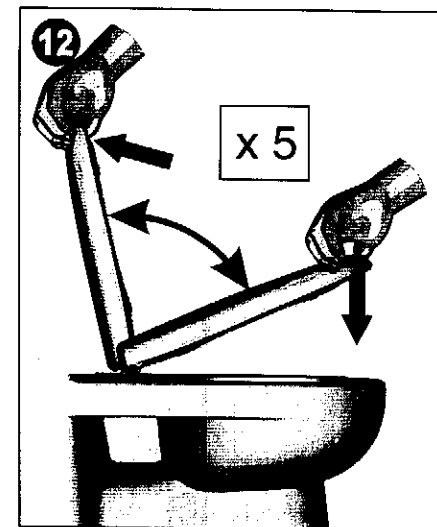
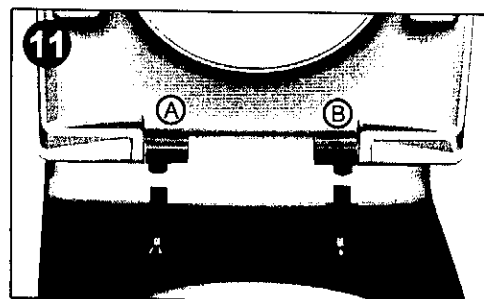
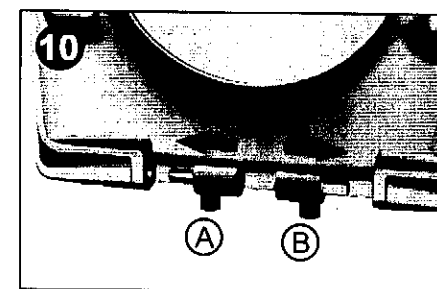
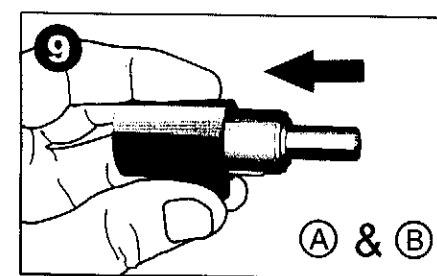
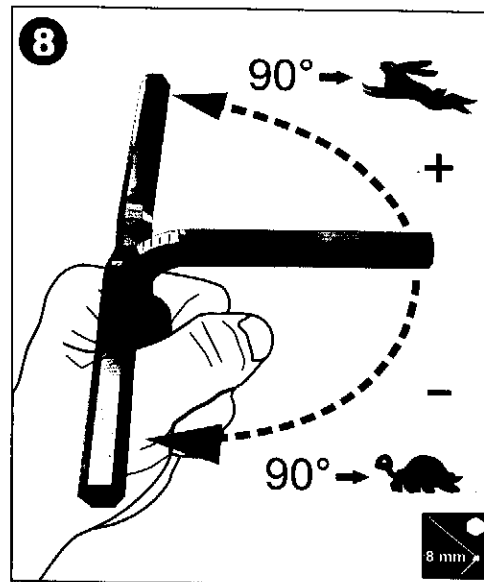
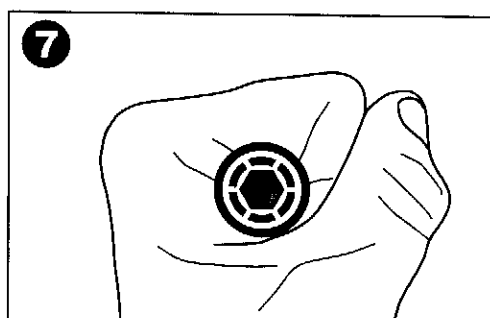
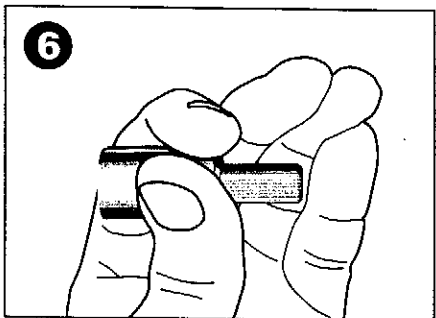
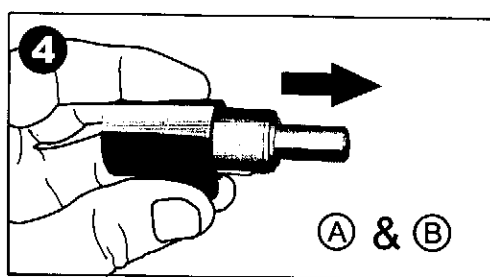
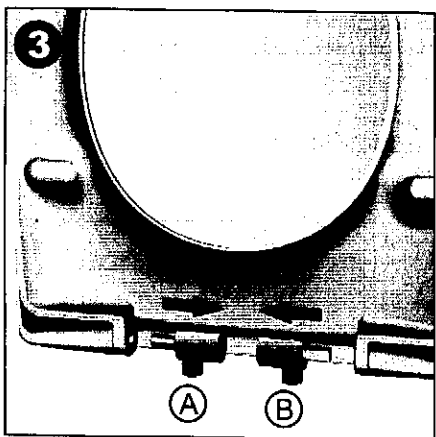
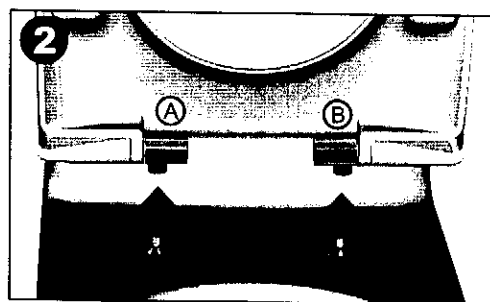
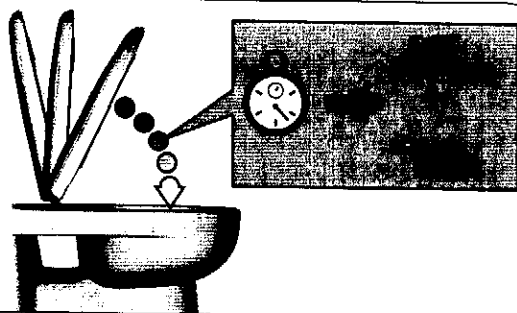

KOLO

www.kolo.eu

